

- ASSEMBLY NOTES:
1. UNLESS DRAWINGS ARE MARKED "FOR CONSTRUCTION", THEY SHALL NOT BE USED FOR CONSTRUCTION PURPOSES
  2. DO NOT OBTAIN DIMENSIONS BY SCALING FROM DRAWING
  3. REMOVE ALL BURRS AND SHARP EDGES
  4. ALL CUTS TO BE A MINIMUM OF CLASS 2  $\sqrt{3.2}$  FINISH UNO

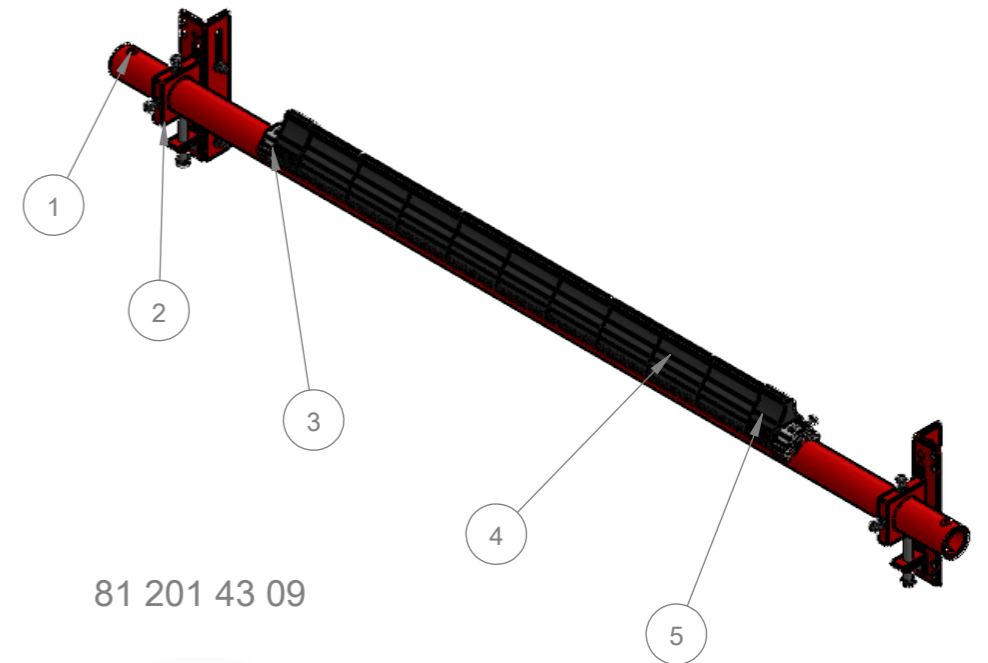

81 201 43 09

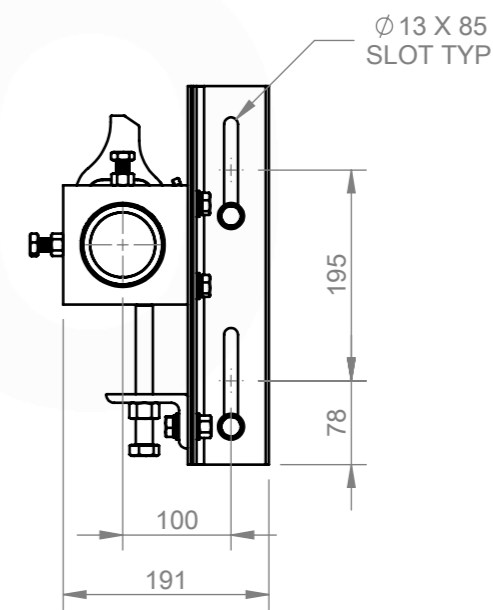
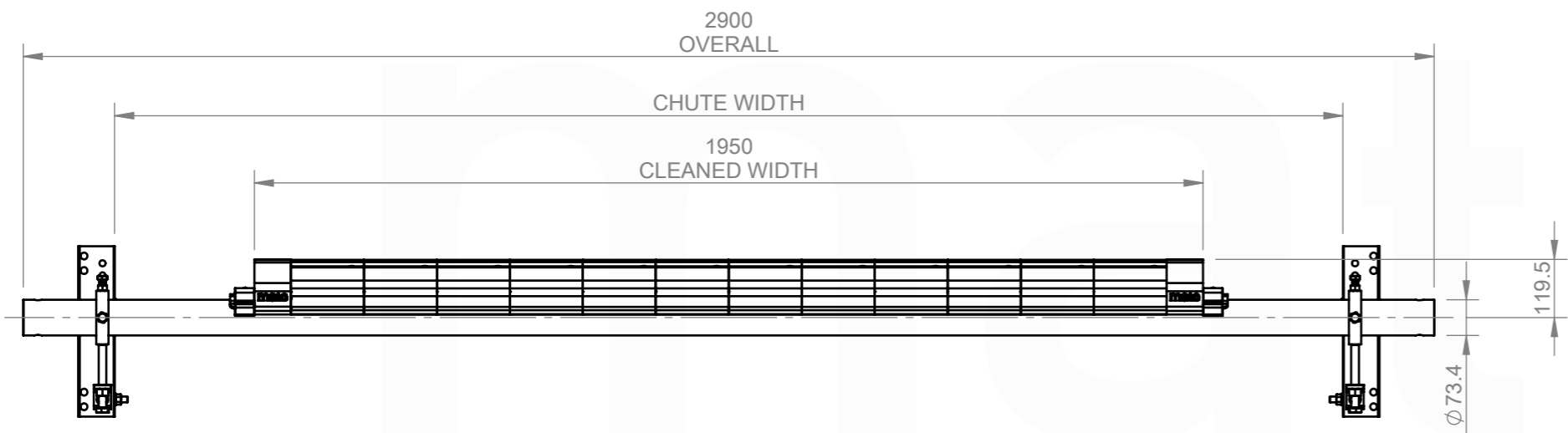

CHUTE CUT OUT DETAIL:  
REFER TO CUT OUT TEMPLATE  
MUS3 BOLT TENSION INSTALLATION TEMPLATE

ITEM NO.	DESCRIPTION	QTY.	PART NO.	MASS K/G
1	MUS SHAFT SUITS 1600mm	1	81 200 21 09	31.71
2	76.1mm MCS2 & 3 & 4 BOLT TENSIONED - MC-POWDERCOATED RED	1	81 210 00 52	8.11
3	MUS2,3 & 4 END STOP	2	81 240 00 07	0.56
4	MUS3 TI BLADE/CUSHION 45 DURO STAINLESS STEEL	9	82 240 00 02	1.09
5	MUS3 POLY END BLADE, 75mm	2	81 240 00 06	0.52

<p>REVISIONS</p> <table border="1"> <thead> <tr> <th>REV.</th> <th>DESCRIPTION</th> <th>BY</th> <th>APR'VD</th> <th>DATE</th> </tr> </thead> <tbody> <tr> <td>A</td> <td>ISSUED FOR CONSTRUCTION</td> <td>JS</td> <td>DG</td> <td>08/10/25</td> </tr> </tbody> </table>					REV.	DESCRIPTION	BY	APR'VD	DATE	A	ISSUED FOR CONSTRUCTION	JS	DG	08/10/25	<p>MACHINING AND FABRICATION TOLERANCES UNO: (ALL DIMENSIONS IN mm)</p> <p>DIMENSIONAL TOLERANCE: PIPE STRAIGHTNESS</p> <p>X.X ±1.0 &lt;1000 ±3.0</p> <p>X.XX ±0.5 &lt;2000 ±6.0</p> <p>X.XXX ±0.1 &lt;3000 ±9.0</p> <p>X.XXXX ±0.01</p> <p>ANGLE: X.X ±1.0° X.XX ±0.5°</p> <p>THERMAL CUTTING: ±1.0</p> <p>WELDMENTS: ±2.0</p> <p>CASTINGS: REFER TO CASTING NOTES</p> <p>MACHINING 'ROUGH' TO ISO 2768-vL</p> <p>MACHINING STD: TO ISO 2768-mK</p> <p>POLYURETHANE: ±2.0</p> <p>WELD SYMBOLS: IN ACCORDANCE TO ISO 2553</p> <p>MACHINED SURFACES UNO:</p> <p>TO BE <math>\sqrt{12.5}</math> WHERE INDICATED 'ROUGH'</p> <p>TO BE <math>\sqrt{3.2}</math> WHERE NOT INDICATED</p>		<p>MATERIAL: N/A</p> <p>FINISH: N/A</p> <p>COLOUR: N/A</p> <p>MFG'D: INTERNAL</p> <p>SCALE: DO NOT SCALE</p>		<p>DRAWN BY: JS</p> <p>CHECKED: DG 08/10/25</p> <p>APPROVED: DG 08/10/25</p> <p>CREATED: 8/10/2025</p>		<p>DESCRIPTION: MUS3-TI-45-BT-2000</p> <p>PART NO.: 81 201 43 11</p> <p>MASS: 60.73 KG</p>		<p>PROFILE CUT ITEMS: TO BE CUT FROM SUPPLIED DXF CAD FILE WHERE APPLICABLE. ADDITIONAL DIMENSIONS CAN BE PROVIDED ON REQUEST. DO NOT SCALE IF IN DOUBT.</p> <p>© COPYRIGHT, ALL RIGHTS RESERVED</p> <p>THIS DRAWING IS STRICTLY CONFIDENTIAL AND MUST NOT BE COPIED, REPRODUCED OR ADAPTED, NOR MAY ARTICLES BE MANUFACTURED IN ACCORDANCE WITH THE DRAWING WITHOUT PRIOR WRITTEN PERMISSION OF MATO AUSTRALIA PTY LTD.</p>		<p><b>mato</b></p> <p>MATO AUSTRALIA PTY LTD (INCORPORATED IN NSW) ABN 82 050 057 726</p> <p>38 BONVILLE AVE THORNTON NSW 2322 PH: 1300 850 795 FAX: (02)4936 1388</p>	
					REV.	DESCRIPTION	BY	APR'VD	DATE																	
A	ISSUED FOR CONSTRUCTION	JS	DG	08/10/25																						
<p>DRAWING NO. 8319</p>		<p>PG. SIZE A3</p>		<p>SHEET 1 / 1</p>		<p>REV A</p>																				

C:\MATO\VAULT\PRODUCTION\NEW FOLDER STRUCTURE\SECONDARY CLEANERS\MUS3\BOLT TENSION\81 201 43 11\CAD FILES\81 201 43 11